

125-W Stereo / 250-W Mono PurePath™ HD Digital-Input Class-D Power Stage

Check for Samples: [TAS5612LA](#)

FEATURES

- **PurePath™ HD Integrated Feedback Provides:**
 - 0.05% THD at 1 W into 4 Ω
 - >65 dB PSRR (No Input Signal)
 - >105 dB (A weighted) SNR
- **Pre-Clipping Output for Control of a Class-G Power Supply**
- **Reduced Heat Sink Size due to use of 60mΩ Output MOSFET with >90% Efficiency at Full Output Power**
- **Output Power at 10%THD+N**
 - 125 W / 4 Ω BTL Stereo Configuration
 - 250 W / 2 Ω in PBTL Mono Configuration
- **Output Power at 1%THD+N**
 - 105 W / 4 Ω BTL Stereo Configuration
 - 55 W / 8 Ω BTL Stereo Configuration
- **Click and Pop Free Startup**
- **Error Reporting Self-protected Design with UVP, Over Temperature, and Short Circuit Protection**
- **EMI Compliant when used with Recommended System Design**
- **44-Pin HTSSOP (DDV) Package for Reduced Board Size**

APPLICATIONS

- Blu-ray™/DVD Receivers
- High Power Sound Bars
- Powered Subwoofer and Active Speakers
- Mini Combo Systems

DESCRIPTION

The TAS5612LA is a feature optimized class-D power amplifier based on the TAS5612A.

The TAS5612LA uses large MOSFETs for improved power efficiency and a novel gate drive scheme for reduced losses in idle and at low output signals leading to reduced heat sink size.

The unique pre clipping output signal can be used to control a Class-G power supply. This combined with the low idle loss and high power efficiency of the TAS5612LA leads to industry leading levels of efficiency ensuring a super “green” system.

The TAS5612LA uses constant voltage gain. The internally matched gain resistors ensure a high Power Supply Rejection Ratio giving an output voltage only dependent on the audio input voltage and free from any power supply artifacts.

The high integration of the TAS5612LA makes the amplifier easy to use and using TI’s reference schematics and PCB layouts leads to fast design in time. The TAS5612LA is available in the space saving surface mount 44-pin HTSSOP package.

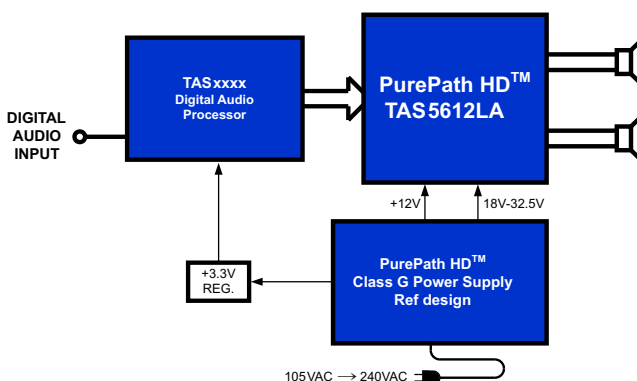

Please be aware that an important notice concerning availability, standard warranty, and use in critical applications of Texas Instruments semiconductor products and disclaimers thereto appears at the end of this data sheet.

PowerPAD, PurePath are trademarks of Texas Instruments.

Blu-ray is a trademark of Blu-ray Disk Association (BDA).

All other trademarks are the property of their respective owners.



These devices have limited built-in ESD protection. The leads should be shorted together or the device placed in conductive foam during storage or handling to prevent electrostatic damage to the MOS gates.

GENERAL INFORMATION

Terminal Assignment

The TAS5612LA is available in a thermally enhanced package:

- 44-Pin HTSSOP package (DDV)

The package contains a PowerPAD™ that is located on the top side of the device for convenient thermal coupling to the heat sink.

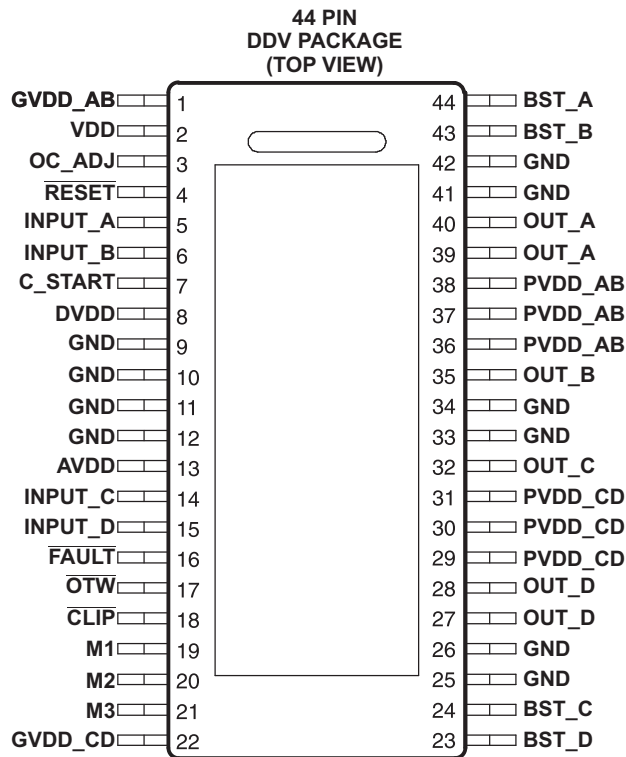

PIN FUNCTIONS

PIN NAME	PINOUT DDV-44	I/O/P ⁽¹⁾	DESCRIPTION
AVDD	13	P	Internal voltage regulator, analog section
BST_A	44	P	Bootstrap pin, A-side
BST_B	43	P	Bootstrap pin, B-side
BST_C	24	P	Bootstrap pin, C-side
BST_D	23	P	Bootstrap pin, D-side
CLIP	18	O	Clipping warning; open drain; active low
C_START	7	O	Startup ramp
DVDD	8	P	Internal voltage regulator, digital section
FAULT	16	O	Shutdown signal, open drain; active low
GND	9, 10, 11, 12, 25, 26, 33, 34, 41, 42	P	Ground
GVDD_AB	1	P	Gate-drive voltage supply; AB-side
GVDD_CD	22	P	Gate-drive voltage supply; CD-side
INPUT_A	5	I	PWM Input signal for half-bridge A
INPUT_B	6	I	PWM Input signal for half-bridge B
INPUT_C	14	I	PWM Input signal for half-bridge C
INPUT_D	15	I	PWM Input signal for half-bridge D
M1	19	I	Mode selection 1 (LSB)
M2	20	I	Mode selection 2
M3	21	I	Mode selection 3 (MSB)
OC_ADJ	3	O	Over-Current threshold programming pin
OTW	17	O	Over-temperature warning; open drain; active low
OUT_A	39, 40	O	Output, half-bridge A
OUT_B	35	O	Output, half-bridge B
OUT_C	32	O	Output, half-bridge C
OUT_D	27, 28	O	Output, half-bridge D
PVDD_AB	36, 37, 38	P	PVDD supply for half-bridge A and B
PVDD_CD	29, 30, 31	P	PVDD supply for half-bridge C and D
RESET	4	I	Device reset Input; active low
VDD	2	P	Input power supply
PowerPAD™		P	Ground, connect to grounded heat sink

(1) I = Input, O = Output, P = Power

Table 1. ORDERING INFORMATION⁽¹⁾

T _A	PACKAGE	DESCRIPTION
0°C–70°C	TAS5612LADDV	44 pin HTSSOP
	TAS5612LADDVR	

(1) For the most current package and ordering information, see the Package Option Addendum at the end of this document, or see the TI website at www.ti.com.

ABSOLUTE MAXIMUM RATINGS

over operating free-air temperature range unless otherwise noted ⁽¹⁾

		TAS5612LA	UNIT
VDD to GND, GVDD_X ⁽²⁾ to GND		-0.3 to 13.2	V
PVDD_X ⁽²⁾ to GND ⁽³⁾ , OUT_X to GND ⁽³⁾ , BST_X to GVDD_X ⁽²⁾⁽³⁾		-0.3 to 50	V
BST_X to GND ⁽³⁾⁽⁴⁾		-0.3 to 62.5	V
DVDD to GND		-0.3 to 4.2	V
AVDD to GND		-0.3 to 8.5	V
OC_ADJ, M1, M2, M3, C_START, INPUT_X to GND		-0.3 to 4.2	V
RESET, FAULT, OTW, CLIP, to GND		-0.3 to 4.2	V
Maximum continuous sink current (FAULT, OTW, CLIP)		9	mA
Maximum operating junction temperature range, T _J		0 to 150	°C
Storage temperature, T _{stg}		-40 to 150	°C
Lead temperature		260	°C
Electrostatic discharge	Human body model ⁽⁴⁾ (all pins)	±2	kV
	Charged device model ⁽⁴⁾ (all pins)	±500	V

- (1) Stresses beyond those listed under *Absolute Maximum Ratings* may cause permanent damage to the device. These are stress ratings only, and functional operation of the device at these or any other conditions beyond those indicated under *Recommended Operating Conditions* is not implied. Exposure to absolute-maximum-rated conditions for extended periods may affect device reliability.
- (2) GVDD_X and PVDD_X represents a full bridge gate drive or power supply. GVDD_X is GVDD_AB or GVDD_CD, PVDD_X is PVDD_AB or PVDD_CD
- (3) These voltages represents the DC voltage + peak AC waveform measured at the terminal of the device in all conditions.
- (4) Maximum BST_X to GND voltage is the sum of maximum PVDD to GND and GVDD to GND voltages minus a diode drop.

THERMAL INFORMATION

THERMAL METRIC ⁽¹⁾		TAS5612LA	UNITS
		DDV (44-PIN)	
θ_{JH}	Junction-to-heat sink thermal resistance ⁽²⁾	2.3	°C/W
θ_{JCTop}	Junction-to-case (top) thermal resistance	0.8	
θ_{JB}	Junction-to-board thermal resistance	2.1	
Ψ_{JT}	Junction-to-top characterization parameter	0.8	
Ψ_{JB}	Junction-to-board characterization parameter	2.1	
θ_{JCbott}	Junction-to-case (bottom) thermal resistance	n/a	

- (1) For more information about traditional and new thermal metrics, see the *IC Package Thermal Metrics* application report, [SPRA953](#).
- (2) Thermal data are obtained with 85°C heat sink temperature using thermal compound with 0.7W/mK thermal conductivity and 2mil thickness.

RECOMMENDED OPERATING CONDITIONS

		MIN	TYP	MAX	UNIT	
PVDD_X	Full-bridge supply	DC supply voltage	12	32.5	34	V
GVDD_X	Supply for logic regulators and gate-drive circuitry	DC supply voltage	10.8	12	13.2	V
VDD	Digital regulator supply voltage	DC supply voltage	10.8	12	13.2	V
R _L	Load impedance	BTL	3.0	4.0	Ω	
		SE	1.5	3.0		
		PBTL	1.5	2.0		
L _{OUTPUT}	Output filter inductance	Minimum inductance at overcurrent limit, including inductor tolerance, temperature and possible inductor saturation			5	μH
F _{PWM}	PWM frame rate		352	384	500	kHz
C _{PVDD}	PVDD close decoupling capacitors		0.44	1		μF
C_START	Startup ramp capacitor	BTL and PBTL configuration	100			nF
		SE and 1xBTL+2xSE configuration	1			μF

RECOMMENDED OPERATING CONDITIONS (continued)

			MIN	TYP	MAX	UNIT
R _{OC}	Over-current programming resistor	Resistor tolerance = 5%	24		33	kΩ
R _{OC_LATCHED}	Over-current programming resistor	Resistor tolerance = 5%	47	62	68	kΩ
T _J	Junction temperature		0		125	°C

MODE SELECTION PINS

MODE PINS			PWM Input ⁽¹⁾	Output Configuration	Input A	Input B	Input C	Input D	MODE
M3	M2	M1							
0	0	0	2N + 1	2 x BTL	PWMA	PWMB	PWMC	PWMD	AD Mode
0	0	1	1N + 1 ⁽²⁾	2 x BTL	PWMA	Unused	PWMC	Unused	AD Mode
0	1	0	2N + 1	2 x BTL	PWMA	PWMB	PWMC	PWMD	BD Mode
0	1	1	1N + 1 ⁽²⁾	1 x BTL + 2 x SE	PWMA	Unused	PWMC	PWMD	AD Mode
1	0	0	2N + 1	1 x PBTL	PWMA	PWMB	0	0	AD Mode
1	0	0	1N + 1 ⁽²⁾	1 x PBTL	PWMA	Unused	0	1	AD Mode
1	0	0	2N + 1	1 x PBTL	PWMA	PWMB	1	0	BD Mode
1	0	1	1N + 1	4 x SE ⁽³⁾	PWMA	PWMB	PWMC	PWMD	AD Mode

- (1) The 1N and 2N naming convention is used to indicate the number of PWM lines to the power stage per channel in a specific mode.
 (2) Using 1N interface in BTL and PBTL mode results in increased DC offset on the output terminals.
 (3) The 4xSE mode can be used as 1xBTL + 2xSE configuration by feeding a 2N PWM signal to either INPUT_AB or INPUT_CD for improved DC offset accuracy

TYPICAL SYSTEM BLOCK DIAGRAM

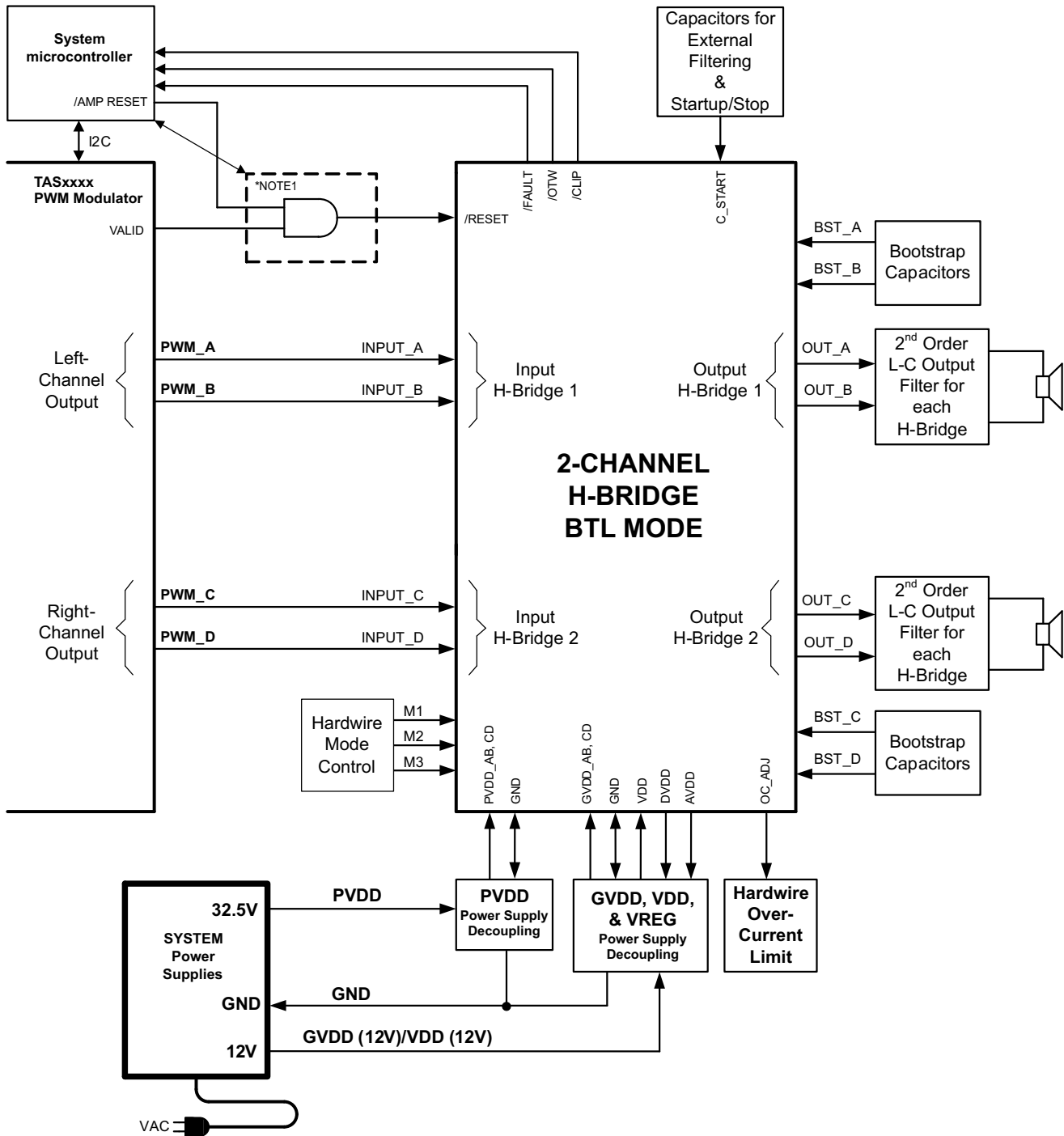

(1) Logic AND is inside or outside the micro processor.

FUNCTIONAL BLOCK DIAGRAM

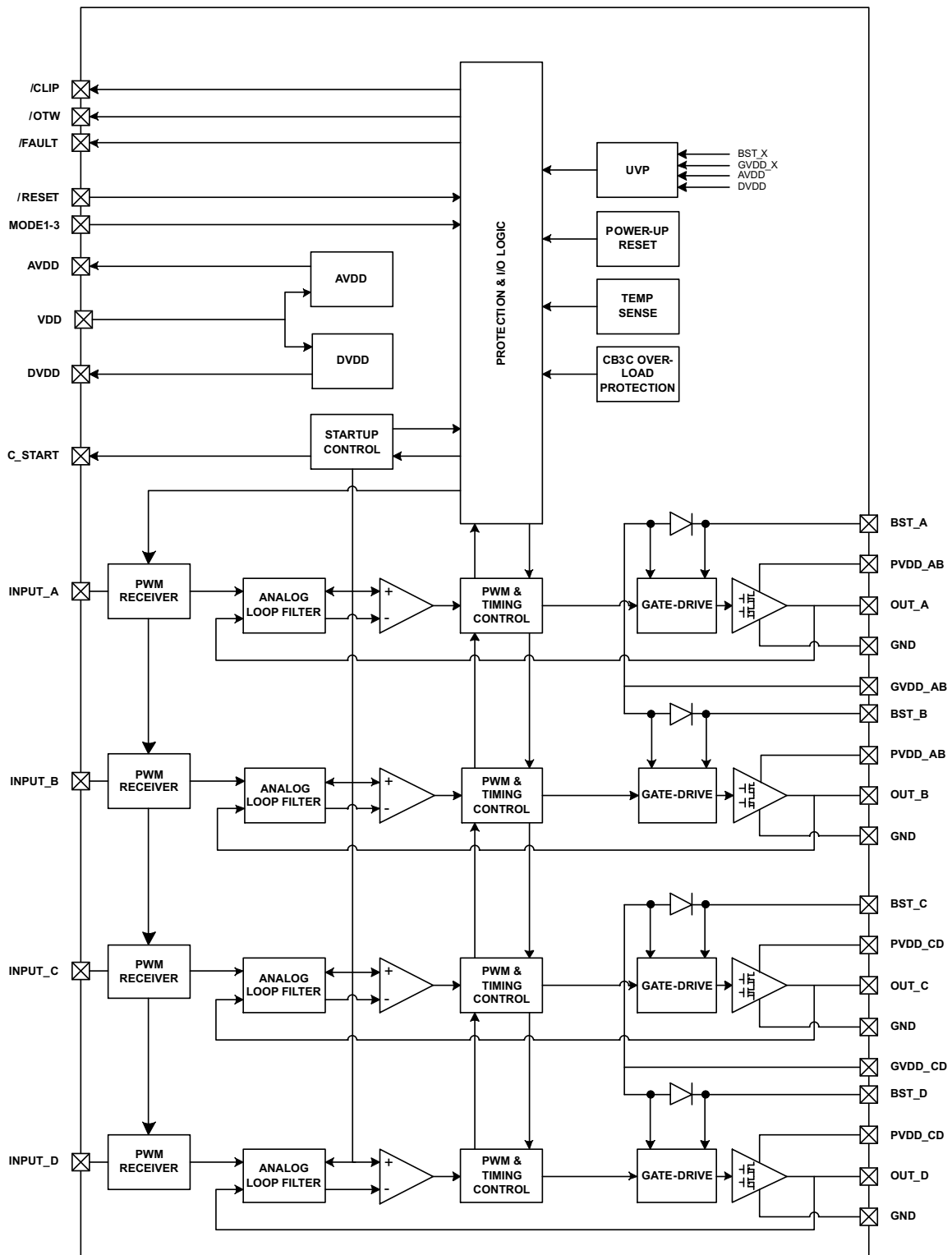

AUDIO SPECIFICATION STEREO (BTL)

Audio performance is recorded as a chipset consisting of a **TASxxxx** PWM Processor (modulation index limited to 97.7%) and a TAS5612LA power stage with PCB and system configurations in accordance with recommended guidelines. Audio frequency = 1kHz, PVDD_X = 32.5V, GVDD_X = 12 V, R_L = 4 Ω, f_s = 384 kHz, R_{OC} = 24 kΩ, T_C = 75°C, Output Filter: L_{DEM} = 10 μH, C_{DEM} = 1 μF, unless otherwise noted.

PARAMETER		TEST CONDITIONS	MIN	TYP	MAX	UNIT
P _O	Power output per channel	R _L = 4 Ω, 10% THD+N		125		W
		R _L = 4 Ω, 1% THD+N		105		
THD+N	Total harmonic distortion + noise	1 W, 1 kHz signal		0.05		%
V _n	Output integrated noise	A-weighted, AES17 measuring filter		180		μV
V _{OS}	Output offset voltage	No signal		10	20	mV
SNR	Signal-to-noise ratio ⁽¹⁾	A-weighted, AES17 measuring filter		105		dB
DNR	Dynamic range	A-weighted, -60 dBFS (rel 1% THD+N)		105		dB
P _{idle}	Power dissipation due to Idle losses (IPVDD_X)	P _O = 0, channels switching ⁽²⁾		1.2		W

(1) SNR is calculated relative to 1% THD-N output level.

(2) Actual system idle losses also are affected by core losses of output inductors.

AUDIO SPECIFICATION 4 CHANNELS (SE)

Audio performance is recorded as a chipset consisting of a **TASxxxx** PWM Processor (modulation index limited to 97.7%) and a TAS5612LA power stage with PCB and system configurations in accordance with recommended guidelines. Audio frequency = 1kHz, PVDD_X = 32.5V, GVDD_X = 12V, R_L = 4Ω, f_s = 384 kHz, R_{OC} = 24kΩ, T_C = 75°C, Output Filter: L_{DEM} = 10μH, C_{DEM} = 1μF, C_{DCB} = 470μF, unless otherwise noted.

PARAMETER		TEST CONDITIONS	MIN	TYP	MAX	UNIT
P _O	Power output per channel	R _L = 3 Ω, 10% THD+N		43		W
		R _L = 3 Ω, 1% THD+N		35		
THD+N	Total harmonic distortion + noise	1 W, 1 kHz signal		0.04		%
V _n	Output integrated noise	A-weighted, AES17 measuring filter		180		μV
SNR	Signal-to-noise ratio ⁽¹⁾	A-weighted, AES17 measuring filter		102		dB
DNR	Dynamic range	A-weighted, -60 dBFS (rel 1% THD+N)		102		dB
P _{idle}	Power dissipation due to Idle losses (IPVDD_X)	P _O = 0, channels switching ⁽²⁾		1.2		W

(1) SNR is calculated relative to 1% THD-N output level.

(2) Actual system idle losses also are affected by core losses of output inductors.

AUDIO SPECIFICATION MONO (PBTL)

Audio performance is recorded as a chipset consisting of a [TASxxxx](#) PWM Processor (modulation index limited to 97.7%) and a TAS5612LA power stage with PCB and system configurations in accordance with recommended guidelines. Audio frequency = 1kHz, PVDD_X = 32.5V, GVDD_X = 12V, R_L = 4Ω, f_S = 384kHz, R_{OC} = 24kΩ, T_C = 75°C, Output Filter: L_{DEM} = 10μH, C_{DEM} = 1μF, unless otherwise noted.

PARAMETER		TEST CONDITIONS	MIN	TYP	MAX	UNIT
P _O	Power output per channel	R _L = 2 Ω, 10%, THD+N		250		W
		R _L = 3 Ω, 10% THD+N		165		
		R _L = 4 Ω, 10% THD+N		130		
		R _L = 2 Ω, 1% THD+N		210		
		R _L = 3 Ω, 1% THD+N		135		
		R _L = 4 Ω, 1% THD+N		105		
THD+N	Total harmonic distortion + noise	1 W, 1 kHz signal		0.025		%
V _n	Output integrated noise	A-weighted, AES17 measuring filter		180		μV
V _{OS}	Output offset voltage	No signal		10	20	mV
SNR	Signal to noise ratio ⁽¹⁾	A-weighted, AES17 measuring filter		105		dB
DNR	Dynamic range	A-weighted, –60 dBFS (rel 1% THD)		105		dB
P _{idle}	Power dissipation due to idle losses (IPVDD_X)	P _O = 0, All channels switching ⁽²⁾		1.2		W

(1) SNR is calculated relative to 1% THD-N output level.

(2) Actual system idle losses are affected by core losses of output inductors.

ELECTRICAL CHARACTERISTICS

PVDD_X = 32.5 V, GVDD_X = 12 V, VDD = 12 V, T_C (Case temperature) = 75°C, f_S = 384 kHz, unless otherwise specified.

PARAMETER		TEST CONDITIONS	MIN	TYP	MAX	UNIT
INTERNAL VOLTAGE REGULATOR AND CURRENT CONSUMPTION						
DVDD	Voltage regulator, only used as a reference node	VDD = 12 V	3.0	3.3	3.6	V
AVDD	Voltage regulator, only used as a reference node	VDD = 12 V		7.8		V
I _{VDD}	VDD supply current	Operating, 50% duty cycle		20		mA
		Idle, reset mode		20		
I _{GVDD_X}	Gate-supply current per full-bridge	50% duty cycle		9		mA
		Reset mode		2		
I _{PVDD_X}	Full-bridge idle current	50% duty cycle without load		18		mA
		RESET low		1.7		
		VDD and GVDD_X at 0V		0.35		
OUTPUT-STAGE MOSFETS						
R _{DS(on), LS}	Drain-to-source resistance, low side (LS)	T _J = 25°C, excludes metalization resistance, GVDD = 12 V		60	100	mΩ
R _{DS(on), HS}	Drain-to-source resistance, high side (HS)			60	100	
I/O PROTECTION						
V _{uwp,GVDD}	Undervoltage protection limit, GVDD_X			8.5		V
V _{uwp,GVDD,hyst} ⁽¹⁾				0.7		
V _{uwp,VDD}	Undervoltage protection limit, VDD			8.5		V
V _{uwp,VDD,hyst} ⁽¹⁾				0.7		
V _{uwp,PVDD}	Undervoltage protection limit, PVDD_X			8.5		V
V _{uwp,PVDD,hyst} ⁽¹⁾				0.7		
OTW ⁽¹⁾	Overtemperature warning		115	125	135	°C
OTW _{hyst} ⁽¹⁾	Temperature drop needed below OTW temperature for OTW to be inactive after OTW event.			25		°C
OTE ⁽¹⁾	Overtemperature error		145	155	165	°C

(1) Specified by design.

ELECTRICAL CHARACTERISTICS (continued)

PVDD_X = 32.5 V, GVDD_X = 12 V, VDD = 12 V, T_C (Case temperature) = 75°C, f_S = 384 kHz, unless otherwise specified.

PARAMETER		TEST CONDITIONS	MIN	TYP	MAX	UNIT
OTE-OTW _{differential} ⁽¹⁾	OTE-OTW differential			30		°C
OTE _{HYST} ⁽¹⁾	A device reset is needed to clear $\overline{\text{FAULT}}$ after an OTE event			25		°C
OLPC	Overload protection counter	f _{PWM} = 384 kHz		2.6		ms
I _{OC}	Overcurrent limit protection	Resistor – programmable, nominal peak current in 1Ω load, ROC = 24 kΩ		15		A
I _{OC_LATCHED}	Overcurrent limit protection, latched	Resistor – programmable, nominal peak current in 1Ω load, ROC = 62 kΩ		15		A
I _{OCT}	Overcurrent response time	Time from application of short condition to Hi-Z of affected half bridge		150		ns
I _{PD}	Internal pulldown resistor at output of each half bridge	Connected when $\overline{\text{RESET}}$ is active to provide bootstrap charge. Not used in SE mode.		3		mA
STATIC DIGITAL SPECIFICATIONS						
V _{IH}	High level input voltage	INPUT_X, M1, M2, M3, $\overline{\text{RESET}}$	1.9			V
V _{IL}	Low level input voltage				0.8	V
LEAKAGE	Input leakage current				100	μA
OTW / SHUTDOWN (FAULT)						
R _{INT_PU}	Internal pullup resistance, $\overline{\text{OTW}}$, $\overline{\text{CLIP}}$, $\overline{\text{FAULT}}$ to DVDD		20	26	33	kΩ
V _{OH}	High level output voltage	Internal pullup resistor	3	3.3	3.6	V
V _{OL}	Low level output voltage	I _O = 4mA		200	500	mV
FANOUT	Device fanout $\overline{\text{OTW}}$, $\overline{\text{FAULT}}$, $\overline{\text{CLIP}}$	No external pullup		30		devices

TYPICAL CHARACTERISTICS, BTL CONFIGURATION

Measurement conditions are: 1kHz, PVDD_X = 32.5 V, GVDD_X = 12 V, R_L = 4Ω, f_S = 384 kHz, R_{OC} = 24 kΩ, T_C = 75°C, Output Filter: L_{DEM} = 10 μH, C_{DEM} = 1 μF, 20Hz to 20kHz BW (AES17 low pass filter), unless otherwise noted.

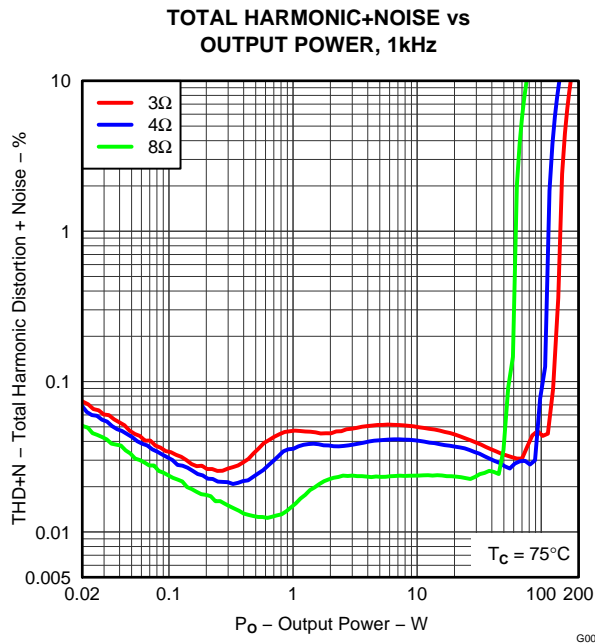

Figure 1.

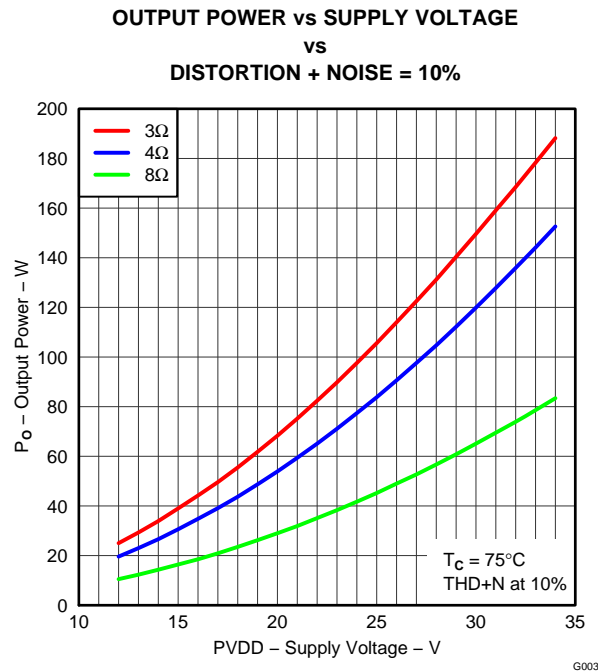

Figure 2.

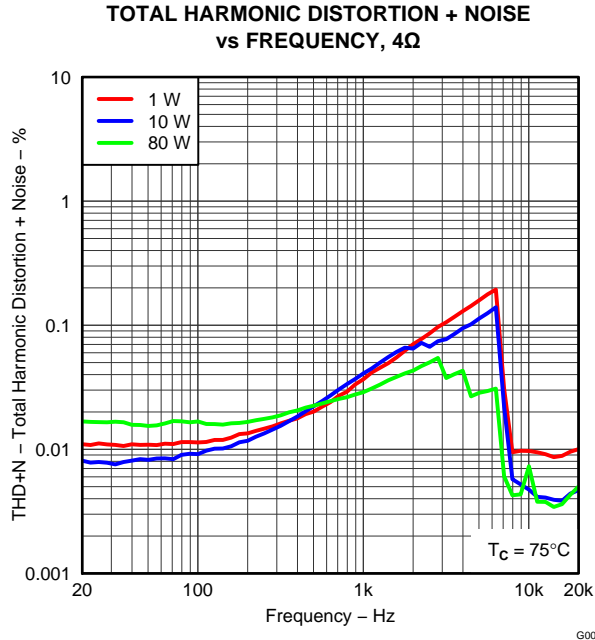

Figure 3.

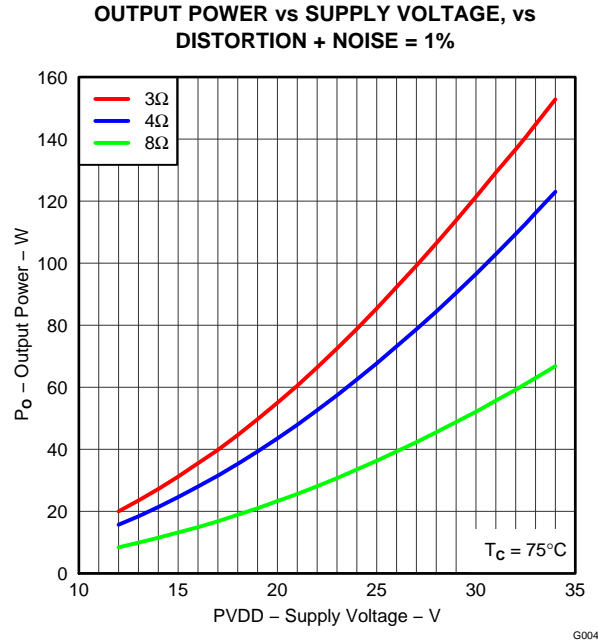

Figure 4.

TYPICAL CHARACTERISTICS, BTL CONFIGURATION (continued)

Measurement conditions are: 1kHz, PVDD_X = 32.5 V, GVDD_X = 12 V, R_L = 4Ω, f_s = 384 kHz, R_{OC} = 24 kΩ, T_C = 75°C, Output Filter: L_{DEM} = 10 μH, C_{DEM} = 1 μF, 20Hz to 20kHz BW (AES17 low pass filter), unless otherwise noted.

SYSTEM EFFICIENCY vs OUTPUT POWER

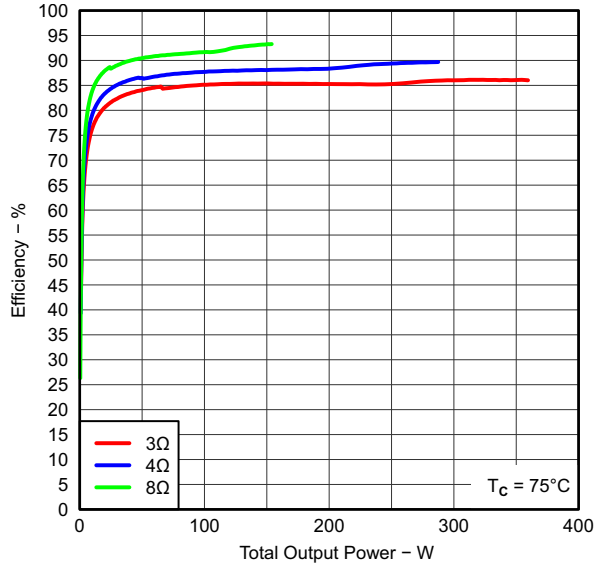

Figure 5.

SYSTEM POWER LOSS vs OUTPUT POWER

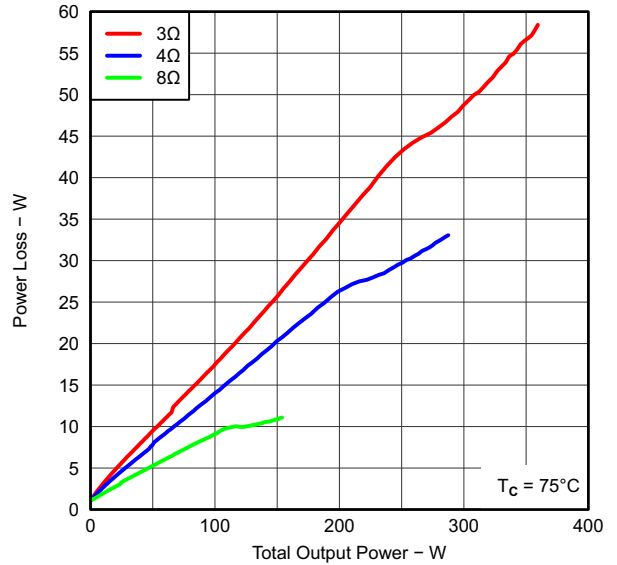

Figure 6.

OUTPUT POWER vs TEMPERATURE

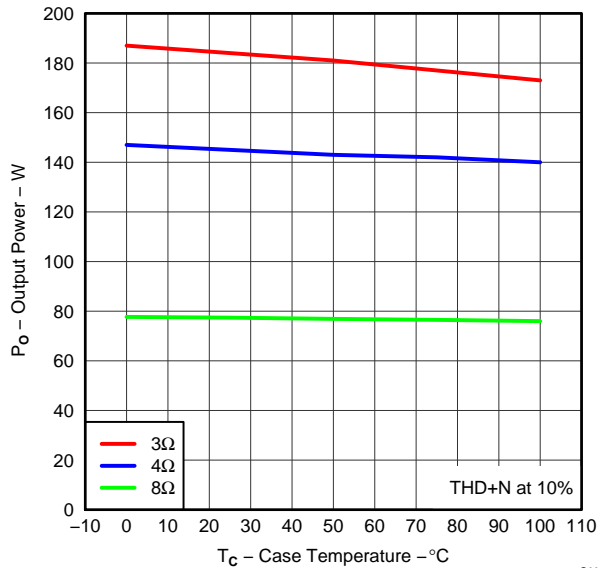

Figure 7.

NOISE AMPLITUDE vs FREQUENCY

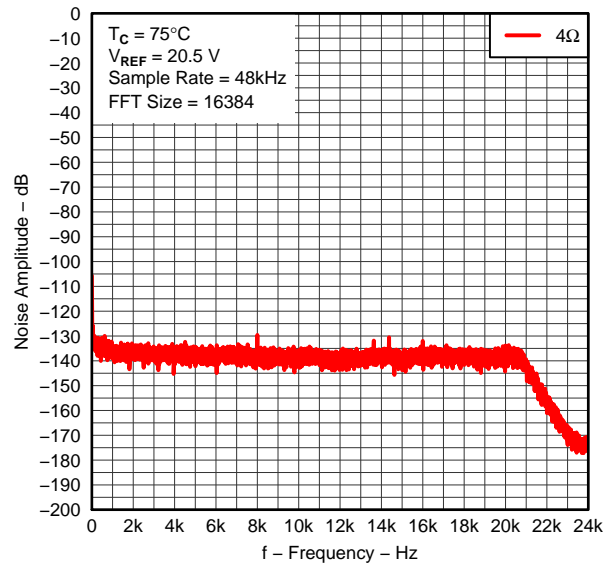

Figure 8.

TYPICAL CHARACTERISTICS, SE CONFIGURATION

Measurement conditions are: 1kHz, PVDD_X = 32.5 V, GVDD_X = 12 V, R_L = 4 Ω, f_s = 384 kHz, R_{OC} = 24kΩ, T_C = 75°C, Output Filter: L_{DEM} = 10 μH, C_{DEM} = 1 μF, C_{DCB} = 470 μF, 20 Hz to 20 kHz BW (AES17 low pass filter), unless otherwise noted.

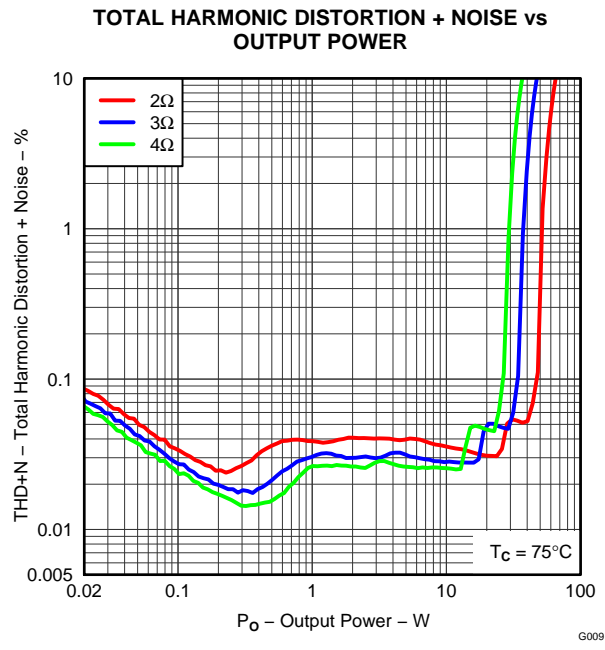

Figure 9.

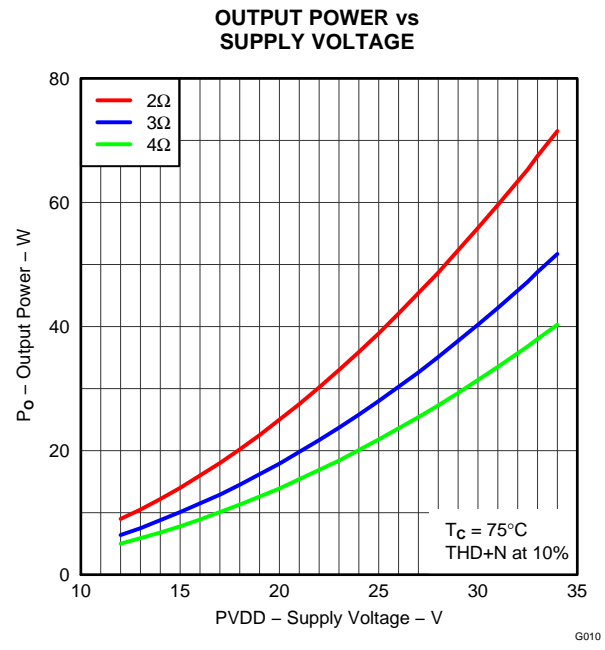

Figure 10.

TYPICAL CHARACTERISTICS, PBTL CONFIGURATION

Measurement conditions are: 1 kHz, PVDD_X = 32.5 V, GVDD_X = 12 V, R_L = 4 Ω, f_s = 384 kHz, R_{OC} = 24kΩ, T_C = 75°C, Output Filter: L_{DEM} = 10 μH, C_{DEM} = 1 μF, 20 Hz to 20 kHz BW (AES17 low pass filter), unless otherwise noted.

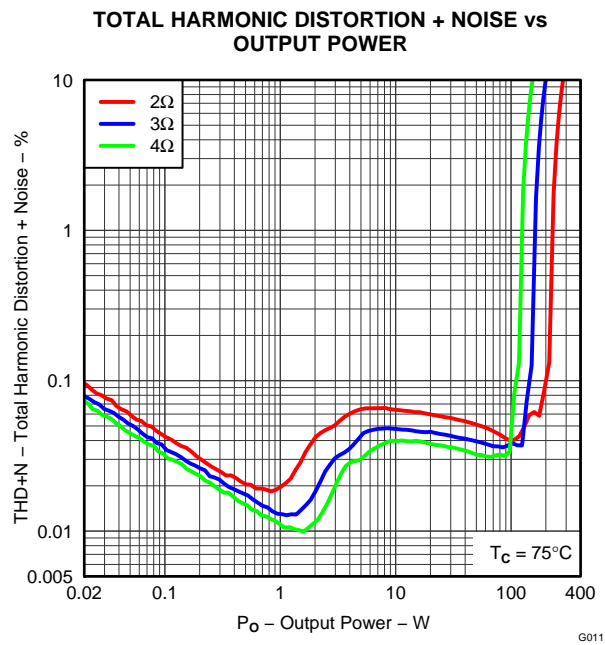

Figure 11.

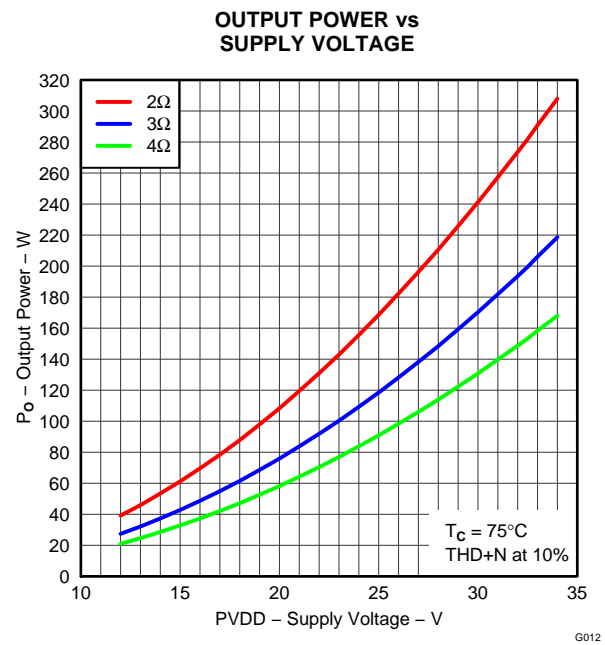

Figure 12.

THEORY OF OPERATION

POWER SUPPLIES

To facilitate system design, the TAS5612LA needs only a 12V supply in addition to the (typical) 32.5 V power-stage supply. An internal voltage regulator provides suitable voltage levels for the digital and low-voltage analog circuitry. Additionally, all circuitry requiring a floating voltage supply, e.g., the high-side gate drive, is accommodated by built-in bootstrap circuitry requiring only an external capacitor for each half-bridge.

To provide outstanding electrical and acoustical characteristics, the PWM signal path including gate drive and output stage is designed as identical, independent half-bridges. For this reason, each half-bridge has separate bootstrap pins (BST_X) and each full-bridge has separate power stage supply (PVDD_X) and gate supply (GVDD_X) pins. Furthermore, an additional pin (VDD) is provided as supply for all common circuits. Although supplied from the same 12 V source, it is highly recommended to separate GVDD_AB, GVDD_CD, and VDD on the printed-circuit board (PCB) by RC filters (see application diagram for details). These RC filters provide the recommended high-frequency isolation. Special attention should be paid to placing all decoupling capacitors as close to their associated pins as possible. In general, inductance between the power supply pins and decoupling capacitors must be avoided. (See reference board documentation for additional information.)

Special attention should be paid to the power-stage power supply; this includes component selection, PCB placement, and routing. As indicated, each full-bridge has independent power-stage supply pins (PVDD_X). For optimal electrical performance, EMI compliance, and system reliability, it is important that each PVDD_X connection is decoupled with minimum 2x 220 nF ceramic capacitors placed as close as possible to each supply pin. It is recommended to follow the PCB layout of the TAS5612LA reference design. For additional information on recommended power supply and required components, see the application diagrams in this data sheet.

The 12V supply should be from a low-noise, low-output-impedance voltage regulator. Likewise, the 32.5 V power-stage supply is assumed to have low output impedance and low noise. The power-supply sequence is not critical as facilitated by the internal power-on-reset circuit. Moreover, the TAS5612LA is fully protected against erroneous power-stage turn on due to parasitic gate charging when power supplies are applied. Thus, voltage-supply ramp rates (dV/dt) are non-critical within the specified range (see the [Recommended Operating Conditions](#) table of this data sheet).

Boot Strap Supply

For a properly functioning bootstrap circuit, a small ceramic capacitor must be connected from each bootstrap pin (BST_X) to the power-stage output pin (OUT_X). When the power-stage output is low, the bootstrap capacitor is charged through an internal diode connected between the gate-drive power-supply pin (GVDD_X) and the bootstrap pin. When the power-stage output is high, the bootstrap capacitor potential is shifted above the output potential and thus provides a suitable voltage supply for the high-side gate driver. In an application with PWM switching frequencies in the range from 300kHz to 400 kHz, it is recommended to use 33 nF ceramic capacitors, size 0603 or 0805, for the bootstrap supply. These 33-nF capacitors ensure sufficient energy storage, even during minimal PWM duty cycles, to keep the high-side power stage FET (LDMOS) fully turned on during the remaining part of the PWM cycle.

SYSTEM POWER-UP/POWER-DOWN SEQUENCE

Powering Up

The TAS5612LA does not require a power-up sequence. The outputs of the H-bridges remain in a high-impedance state until the gate-drive supply voltage (GVDD_X) and VDD voltage are above the undervoltage protection (UVP) voltage threshold (see the [Electrical Characteristics](#) table of this data sheet). Although not specifically required, it is recommended to hold $\overline{\text{RESET}}$ in a low state while powering up the device. This allows an internal circuit to charge the external bootstrap capacitors by enabling a weak pulldown of the half-bridge output.

Powering Down

The TAS5612LA does not require a power-down sequence. The device remains fully operational as long as the gate-drive supply (GVDD_X) voltage and VDD voltage are above the undervoltage protection (UVP) voltage threshold (see the [Electrical Characteristics](#) table of this data sheet). Although not specifically required, it is a good practice to hold $\overline{\text{RESET}}$ low during power down, thus preventing audible artifacts including pops or clicks.

STARTUP AND SHUTDOWN RAMP SEQUENCE

The integrated startup and stop sequence ensures a click and pop free startup and shutdown sequence of the amplifier. The startup sequence uses a voltage ramp with a duration set by the CSTART capacitor. The sequence uses the input PWM signals to generate output PWM signals, hence input idle PWM should be present during both startup and shut down ramping sequences.

VDD, GVDD_X and PVDD_X power supplies must be turned on and with settled outputs before starting the startup ramp by setting $\overline{\text{RESET}}$ high.

During startup and shutdown ramp the input PWM signals should be in muted condition with the PWM processor noise shaper activity turned off (50% duty cycle).

The duration of the startup and shutdown ramp is 100 ms + X ms, where X is the CSTART capacitor value in nF.

It is recommended to use 100nF CSTART in BTL and PBTL mode and 1 μF in SE mode configuration. This results in ramp times of 200 ms and 1.1s respectively. The longer ramp time in SE configuration allows charge and discharge of the output AC coupling capacitor without audible artifacts.

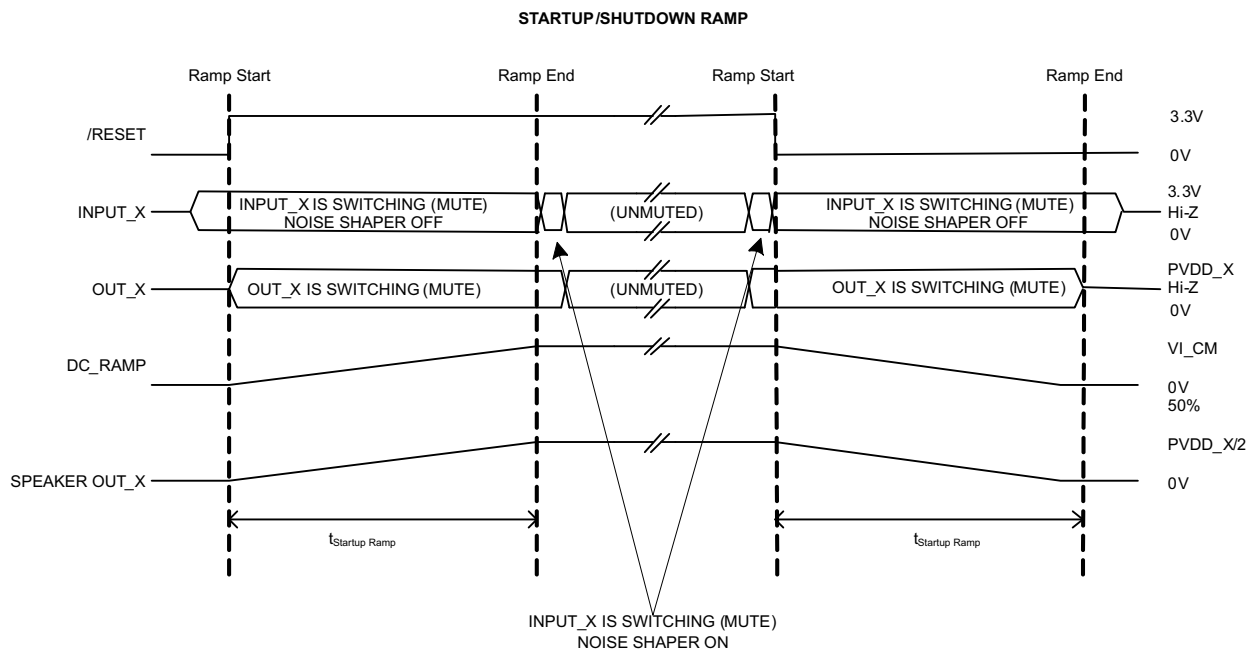

UNUSED OUTPUT CHANNELS

If all available output channels are not used, it is recommended to disable switching of unused output nodes to reduce power consumption. Furthermore by disabling unused output channels the cost of unused output LC demodulation filters can be avoided.

Disabling a channel is done by leave the bootstrap capacitor (BST) unstuffed and connecting the respective input to GND. The unused output pin(s) can be left floating. Please note that the PVDD decoupling capacitors still need to be mounted.

Table 2. Unused Output Channels

Operating Mode	PWM Input	Output Configuration	Unused Channel	INPUT_A	INPUT_B	INPUT_C	INPUT_D	Unstuffed Component
000	2N + 1	2 x BTL	AB	GND	GND	PWMc	PWMd	BST_A & BST_B capacitor BST_C & BST_D capacitor
001	1N + 1		CD	PWMa	PWMb	GND	GND	
010	2N + 1							
101	1N + 1	4 x SE	A	GND	PWMb	PWMc	PWMd	BST_A capacitor
			B	PWMa	GND	PWMc	PWMd	BST_B capacitor
			C	PWMa	PWMb	GND	PWMd	BST_C capacitor
			D	PWMa	PWMb	PWMc	GND	BST_D capacitor

DEVICE PROTECTION SYSTEM

The TAS5612LA contains advanced protection circuitry carefully designed to facilitate system integration and ease of use, as well as to safeguard the device from permanent failure due to a wide range of fault conditions such as short circuits, overload, overtemperature, and undervoltage. The TAS5612LA responds to a fault by immediately setting the power stage in a high-impedance (Hi-Z) state and asserting the FAULT pin low. In situations other than overload and overtemperature error (OTE), the device automatically recovers when the fault condition has been removed, i.e., the supply voltage has increased.

The device will function on errors, as shown in the following table.

Table 3. Device Protection

BTL Mode		PBTL Mode		SE Mode	
Channel Fault	Turns Off	Channel Fault	Turns Off	Channel Fault	Turns Off
A	A+B	A	A+B+C+D	A	A+B
B		B		B	
C	C+D	C		C	C+D
D		D		D	

Bootstrap UVP does not shutdown according to the table, it shuts down the respective high-side FET.

PIN-TO-PIN SHORT CIRCUIT PROTECTION (PPSC)

The PPSC detection system protects the device from permanent damage if a power output pin (OUT_X) is shorted to GND or PVDD_X. For comparison, the OC protection system detects an over current after the demodulation filter where PPSC detects shorts directly at the pin before the filter. PPSC detection is performed at startup i.e. when VDD is supplied, consequently a short to either GND or PVDD_X after system startup will not activate the PPSC detection system. When PPSC detection is activated by a short on the output, all half bridges are kept in a Hi-Z state until the short is removed, the device then continues the startup sequence and starts switching. The detection is controlled globally by a two step sequence. The first step ensures that there are no shorts from OUT_X to GND, the second step tests that there are no shorts from OUT_X to PVDD_X. The total duration of this process is roughly proportional to the capacitance of the output LC filter. The typical duration is <math><15 \text{ ms}/\mu\text{F}</math>. While the PPSC detection is in progress, FAULT is kept low, and the device will not react to changes applied to the RESET pins. If no shorts are present the PPSC detection passes, and FAULT is released. A device reset will not start a new PPSC detection. PPSC detection is enabled in BTL and PBTL output configurations, the detection is not performed in SE mode. To make sure not to trip the PPSC detection system it is recommended not to insert resistive load to GND or PVDD_X.

OVERTEMPERATURE PROTECTION

The TAS5612LA has a two-level temperature-protection system that asserts an active-low warning signal ($\overline{\text{OTW}}$) when the device junction temperature exceeds 125°C (typical). If the device junction temperature exceeds 155°C (typical), the device is put into thermal shutdown, resulting in all half-bridge outputs being set in the high-impedance (Hi-Z) state and FAULT being asserted low. OTE is latched in this case. To clear the OTE latch, $\overline{\text{RESET}}$ must be asserted. Thereafter, the device resumes normal operation.

OVERTEMPERATURE WARNING, $\overline{\text{OTW}}$

The over temperature warning $\overline{\text{OTW}}$ asserts when the junction temperature has exceeded recommended operating temperature. Operation at junction temperatures above $\overline{\text{OTW}}$ threshold is exceeding recommended operation conditions and is strongly advised to avoid.

If $\overline{\text{OTW}}$ asserts, action should be taken to reduce power dissipation to allow junction temperature to decrease until it gets below the $\overline{\text{OTW}}$ hysteresis threshold. This action can be decreasing audio volume or turning on a system cooling fan.

UNDERVOLTAGE PROTECTION (UVP) AND POWER-ON RESET (POR)

The UVP and POR circuits of the TAS5612LA fully protect the device in any power-up/down and brownout situation. While powering up, the POR circuit resets the overload circuit (OLP) and ensures that all circuits are fully operational when the GVDD_X and VDD supply voltages reach stated in the [Electrical Characteristics](#) table. Although GVDD_X and VDD are independently monitored, a supply voltage drop below the UVP threshold on any VDD or GVDD_X pin results in all half-bridge outputs immediately being set in the high-impedance (Hi-Z) state and $\overline{\text{FAULT}}$ being asserted low. The device automatically resumes operation when all supply voltages have increased above the UVP threshold.

ERROR REPORTING

Note that asserting $\overline{\text{RESET}}$ low forces the $\overline{\text{FAULT}}$ signal high, independent of faults being present. TI recommends monitoring the $\overline{\text{OTW}}$ signal using the system micro controller and responding to an overtemperature warning signal by, e.g., turning down the volume to prevent further heating of the device resulting in device shutdown (OTE).

To reduce external component count, an internal pullup resistor to 3.3 V is provided on both $\overline{\text{FAULT}}$, $\overline{\text{CLIP}}$, and $\overline{\text{OTW}}$ outputs.

See [Electrical Characteristics](#) table for actual values.

The $\overline{\text{FAULT}}$, $\overline{\text{OTW}}$, pins are active-low, open-drain outputs. Their function is for protection-mode signaling to a PWM controller or other system-control device.

Any fault resulting in device shutdown is signaled by the $\overline{\text{FAULT}}$ pin going low. Likewise, $\overline{\text{OTW}}$ goes low when the device junction temperature exceeds 125°C (see the following table).

Table 4. Error Reporting

$\overline{\text{FAULT}}$	$\overline{\text{OTW}}$	DESCRIPTION
0	0	Overtemperature (OTE) or overload (OLP) or undervoltage (UVP)
0	1	Overload (OLP) or undervoltage (UVP)
1	0	Junction temperature higher than 125°C (overtemperature warning)
1	1	Junction temperature lower than 125°C and no OLP or UVP faults (normal operation)

FAULT HANDLING

If a fault situation occurs while in operation, the device will act accordingly to the fault being a global or a channel fault. A global fault is a chip-wide fault situation and will cause all PWM activity of the device to be shut down, and will assert $\overline{\text{FAULT}}$ low. A global fault is a latching fault and clearing $\overline{\text{FAULT}}$ and restart operation requires resetting the device by toggling $\overline{\text{RESET}}$. Toggling $\overline{\text{RESET}}$ should never be allowed with excessive system temperature, so it is advised to monitor $\overline{\text{RESET}}$ by a system microcontroller and only allow releasing $\overline{\text{RESET}}$ ($\overline{\text{RESET}}$ high) if the $\overline{\text{OTW}}$ signal is cleared (high). A channel fault will result in shutdown of the PWM activity of the affected channel(s). Note that asserting $\overline{\text{RESET}}$ low forces the $\overline{\text{FAULT}}$ signal high, independent of faults being present. TI recommends monitoring the $\overline{\text{OTW}}$ signal using the system micro controller and responding to an over temperature warning signal by, e.g., turning down the volume to prevent further heating of the device resulting in device shutdown (OTE).

Table 5. Fault Handling

Fault/Event	Fault/Event Description	Global or Channel	Reporting Method	Latched/Self Clearing	Action needed to Clear	Output FETs
PVDD_X UVP	Voltage Fault	Global	$\overline{\text{FAULT}}$ Pin	Self Clearing	Increase affected supply voltage	Hi-Z
VDD UVP						
GVDD_X UVP						
AVDD UVP						
POR (DVDD UVP)	Power On Reset	Global	$\overline{\text{FAULT}}$ Pin	Self Clearing	Allow DVDD to rise	H-Z
BST UVP	Voltage Fault	Channel (half bridge)	None	Self Clearing	Allow BST cap to recharge (low side on, VDD 12V)	HighSide Off

Table 5. Fault Handling (continued)

Fault/Event	Fault/Event Description	Global or Channel	Reporting Method	Latched/Self Clearing	Action needed to Clear	Output FETs
OTW	Thermal Warning	Global	$\overline{\text{OTW}}$ Pin	Self Clearing	Cool below lower OTW threshold	Normal operation
OTE (OTSD)	Thermal Shutdown	Global	$\overline{\text{FAULT}}$ Pin	Latched	Toggle $\overline{\text{RESET}}$	Hi-Z
OLP (CBC >2.6ms)	OC shutdown	Channel	$\overline{\text{FAULT}}$ Pin	Latched	Toggle $\overline{\text{RESET}}$	Hi-Z
Latched OC (ROC >47k)	OC shutdown	Channel	$\overline{\text{FAULT}}$ Pin	Latched	Toggle $\overline{\text{RESET}}$	Hi-Z
CBC (24k<ROC<33k)	OC Limiting	Channel	None	Self Clearing	reduce signal level or remove short	Flip state, cycle by cycle at fs/2
Stuck at Fault ⁽¹⁾ (1 to 3 channels)	No PWM	Channel	None	Self Clearing	resume PWM	Hi-Z
Stuck at Fault ⁽¹⁾ (All channels)	No PWM	Global	None	Self Clearing	resume PWM	Hi-Z

(1) Stuck at Fault occurs when input PWM drops below minimum PWM frame rate given in RECOMEMNDED OPERATING CONDITIONS.

DEVICE RESET

When $\overline{\text{RESET}}$ is asserted low, all power-stage FETs in the four half-bridges are forced into a high-impedance (Hi-Z) state.

In BTL modes, to accommodate bootstrap charging prior to switching start, asserting the reset input low enables weak pulldown of the half-bridge outputs. In the SE mode, the output is forced into a high impedance state when asserting the reset input low. Asserting reset input low removes any fault information to be signaled on the $\overline{\text{FAULT}}$ output, i.e., $\overline{\text{FAULT}}$ is forced high. A rising-edge transition on reset input allows the device to resume operation after an overload fault. To ensure thermal reliability, the rising edge of $\overline{\text{RESET}}$ must occur no sooner than 4 ms after the falling edge of $\overline{\text{FAULT}}$.

SYSTEM DESIGN CONSIDERATION

A rising-edge transition on reset input allows the device to execute the startup sequence and starts switching.

Apply audio only according to the timing information for startup and shutdown sequence. That will start and stop the amplifier without audible artifacts in the output transducers.

The $\overline{\text{CLIP}}$ signal indicates that the output is approaching clipping (when output PWM starts skipping pulses due to loop filter saturation). The signal can be used to initiate an audio volume decrease or to adjust the power supply rail.

The device inverts the audio signal from input to output.

The DVDD and AVDD pins are not recommended to be used as a voltage source for external circuitry.

APPLICATION INFORMATION

PCB MATERIAL RECOMMENDATION

FR-4 Glass Epoxy material with 1 oz. (35 μm) is recommended for use with the TAS5612LA. The use of this material can provide for higher power output, improved thermal performance, and better EMI margin (due to lower PCB trace inductance).

PVDD CAPACITOR RECOMMENDATION

The large capacitors used in conjunction with each full-bridge, are referred to as the PVDD Capacitors. These capacitors should be selected for proper voltage margin and adequate capacitance to support the power requirements. In practice, with a well designed system power supply, 1000 μF , 50 V should support most applications. The PVDD capacitors should be low ESR type because they are used in a circuit associated with high-speed switching.

DECOUPLING CAPACITOR RECOMMENDATION

To design an amplifier that has robust performance, passes regulatory requirements, and exhibits good audio performance, good quality decoupling capacitors should be used. In practice, X5R or better should be used in this application.

The voltage of the decoupling capacitors should be selected in accordance with good design practices. Temperature, ripple current, and voltage overshoot must be considered. This fact is particularly true in the selection of the close decoupling capacitor that is placed on the power supply to each half-bridge. It must withstand the voltage overshoot of the PWM switching, the heat generated by the amplifier during high power output, and the ripple current created by high power output. A minimum voltage rating of 50V is required for use with a 32.5 V power supply.

See to the TAS5614LADDVEVM User's Guide for more details including layout and Bill-of-Materials.

TYPICAL SE CONFIGURATION

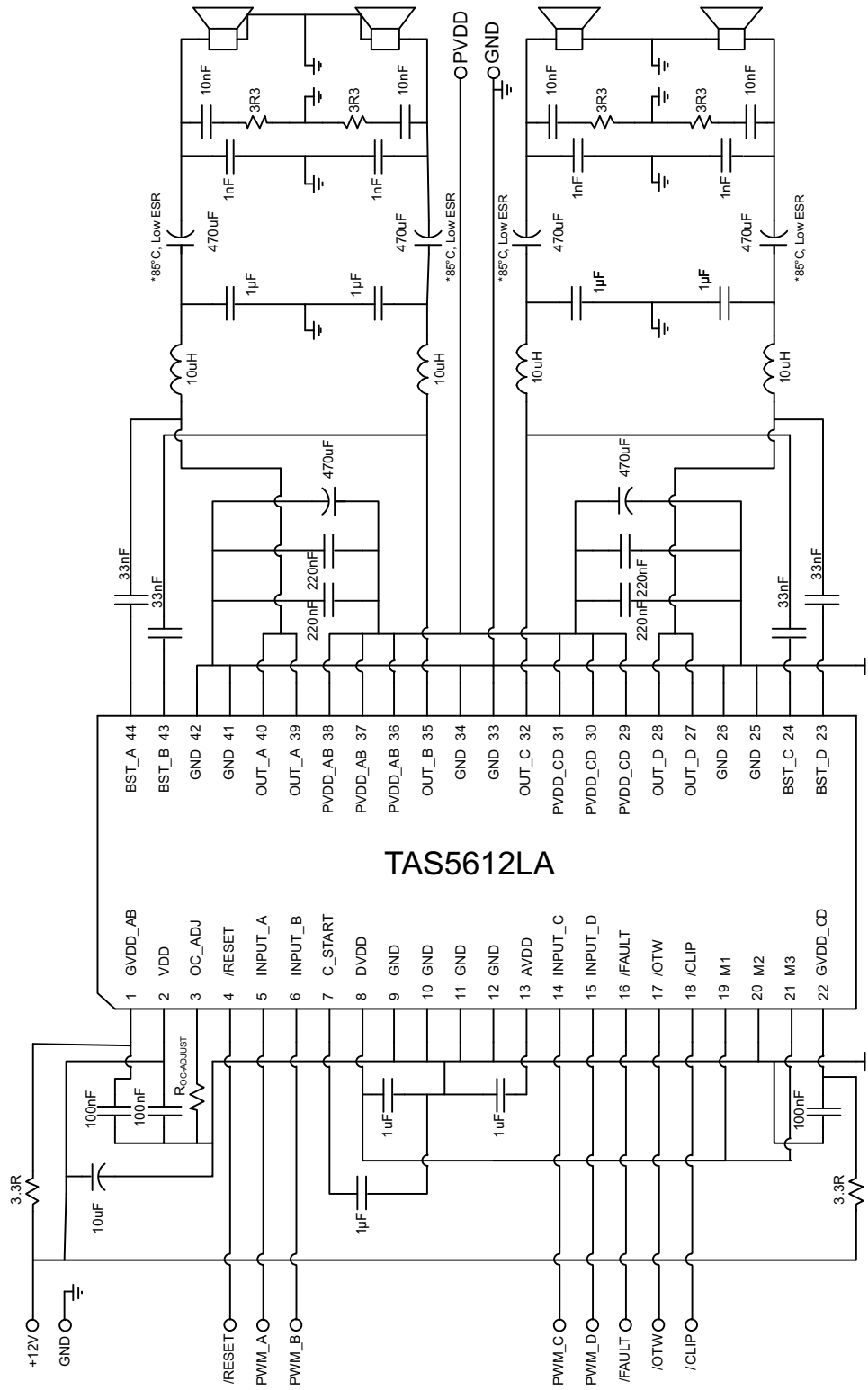

Figure 14. Typical (1N) SE Application

TYPICAL PBTL CONFIGURATION

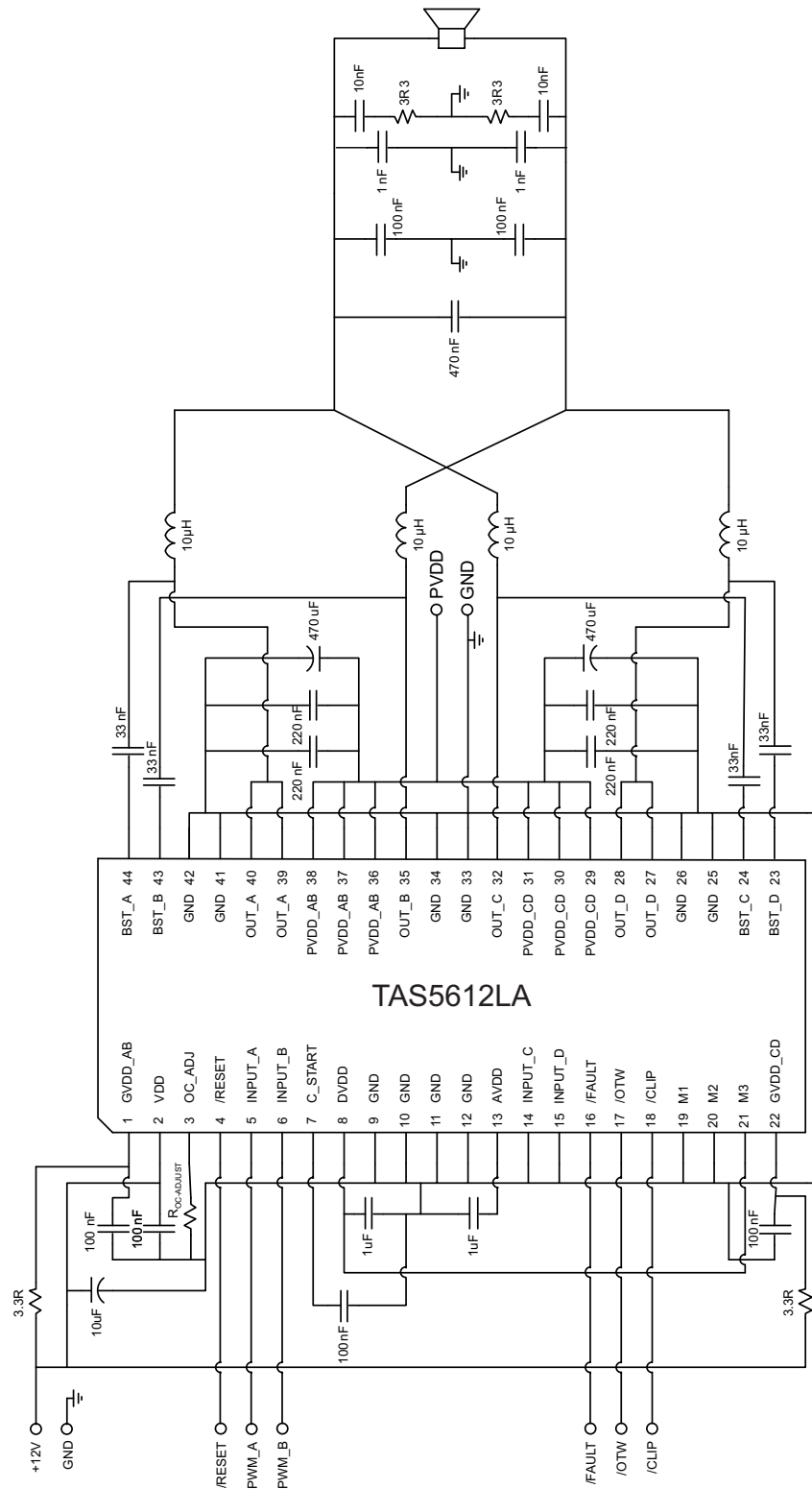

Figure 15. Typical Differential (2N) PBTL Application with AD Modulation Filter

CIRCUIT COMPONENT AND PRINTED CIRCUIT BOARD RECOMMENDATION

These requirements must be followed to achieve best performance and reliability and minimum ground bounce at rated output power of TAS5612LA.

CIRCUIT COMPONENT REQUIREMENTS

A number of circuit components are critical to performance and reliability. They include LC filter inductors and capacitors, decoupling capacitors and the heatsink. The best detailed reference for these is the TAS5612LA EVM BOM in the users guide, which includes components that meet all the following requirements.

- High frequency decoupling capacitors: small high frequency decoupling capacitors are placed next to the IC to control switching spikes and keep high frequency currents in a tight loop to achieve best performance and reliability and EMC. They must be high quality ceramic parts with material like X7R or X5R and voltage ratings at least 30% greater than PVDD, to minimize loss of capacitance caused by applied DC voltage. (Capacitors made of materials like Y5V or Z5U should never be used in decoupling circuits or audio circuits because their capacitance falls dramatically with applied DC and AC voltage, often to 20% of rated value or less.)
- Bulk decoupling capacitors: large bulk decoupling capacitors are placed as close as possible to the IC to stabilize the power supply at lower frequencies. They must be high quality aluminum parts with low ESR and ESL and voltage ratings at least 25% more than PVDD to handle power supply ripple currents and voltages.
- LC filter inductors: to maintain high efficiency, short circuit protection and low distortion, LC filter inductors must be linear to at least the OCP limit and must have low DC resistance and core losses. For SCP, minimum working inductance, including all variations of tolerance, temperature and current level, must be 5 μ H. Inductance variation of more than 1% over the output current range can cause increased distortion.
- LC filter capacitors: to maintain low distortion and reliable operation, LC filter capacitors must be linear to twice the peak output voltage. For reliability, capacitors must be rated to handle the audio current generated in them by the maximum expected audio output voltage at the highest audio frequency.
- Heatsink: The heatsink must be fabricated with the PowerPAD™ contact area spaced 1.0mm +/-0.01mm above mounting areas that contact the PCB surface. It must be supported mechanically at each end of the IC. This mounting ensures the correct pressure to provide good mechanical, thermal and electrical contact with TAS5612LA PowerPAD™. The PowerPAD™ contact area must be bare and must be interfaced to the PowerPAD with a thin layer (about 1mil) of a thermal compound with high thermal conductivity.

PRINTED CIRCUIT BOARD REQUIREMENTS

PCB layout, audio performance, EMC and reliability are linked closely together, and solid grounding improves results in all these areas. The circuit produces high, fast-switching currents, and care must be taken to control current flow and minimize voltage spikes and ground bounce at IC ground pins. Critical components must be placed for best performance and PCB traces must be sized for the high audio currents that the IC circuit produces.

Grounding: ground planes must be used to provide the lowest impedance and inductance for power and audio signal currents between the IC and its decoupling capacitors, LC filters and power supply connection. The area directly under the IC should be treated as central ground area for the device, and all IC grounds must be connected directly to that area. A matrix of vias must be used to connect that area to the ground plane. Ground planes can be interrupted by radial traces (traces pointing away from the IC), but they must never be interrupted by circular traces, which disconnect copper outside the circular trace from copper between it and the IC. Top and bottom areas that do not contain any power or signal traces should be flooded and connected with vias to the ground plane.

Decoupling capacitors: high frequency decoupling capacitors must be located within 2mm of the IC and connected directly to PVDD and GND pins with solid traces. Vias must not be used to complete these connections, but several vias must be used at each capacitor location to connect top ground directly to the ground plane. Placement of bulk decoupling capacitors is less critical, but they still must be placed as close as possible to the IC with strong ground return paths. Typically the heatsink sets the distance.

LC filters: LC filters must be placed as close as possible to the IC after the decoupling capacitors. The capacitors must have strong ground returns to the IC through top and bottom grounds for effective operation.

PCB copper must be at least 1 ounce thickness. PVDD and output traces must be wide enough to carry expected average currents without excessive temperature rise. PWM input traces must be kept short and close together on the input side of the IC and must be shielded with ground flood to avoid interference from high power switching signals.

The heatsink must be grounded well to the PCB near the IC, and a thin layer of highly conductive thermal compound (about 1mil) must be used to connect the heatsink to the PowerPAD.

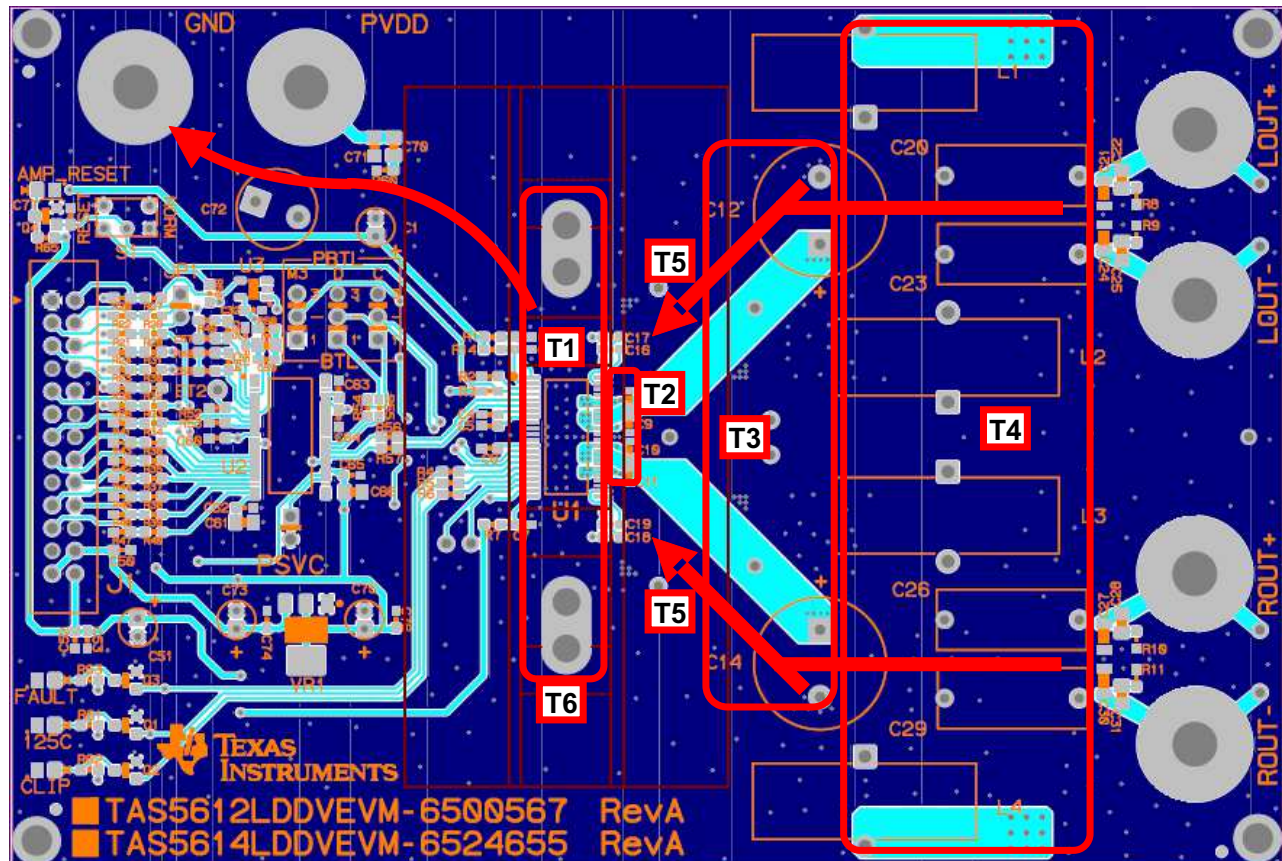

Note T1: Bottom and top layer ground plane areas are used to provide strong ground connections. The area under the IC must be treated as central ground, with IC grounds connected there and a strong via matrix connecting the area to bottom ground plane. The ground path from the IC to the power supply ground through top and bottom layers must be strong to provide very low impedance to high power and audio currents.

Note T2: Low impedance X7R or X5R ceramic high frequency decoupling capacitors must be placed within 2mm of PVDD and GND pins and connected directly to them and to top ground plane to provide good decoupling of high frequency currents for best performance and reliability. Their DC voltage rating must be 2 times PVDD.

Note T3: Low impedance electrolytic bulk decoupling capacitors must be placed as close as possible to the IC. Typically the heat sink sets the distance. Wide PVDD traces are routed on the top layer with direct connections to the pins, without going through vias.

Note T4: LC filter inductors and capacitors must be placed as close as possible to the IC after decoupling capacitors. Inductors must have low DC resistance and switching losses and must be linear to at least the OCP (over current protection) limit. Capacitors must be linear to at least twice the maximum output voltage and must be capable of conducting currents generated by the maximum expected high frequency output.

Note T5: Bulk decoupling capacitors and LC filter capacitors must have strong ground return paths through ground plane to the central ground area under the IC.

Note T6: The heat sink must have a good thermal and electrical connection to PCB ground and to the IC PowerPAD. It must be connected to the PowerPAD through a thin layer, about 1 mil, of highly conductive thermal compound.

Figure 16. Printed Circuit Board - Top Layer

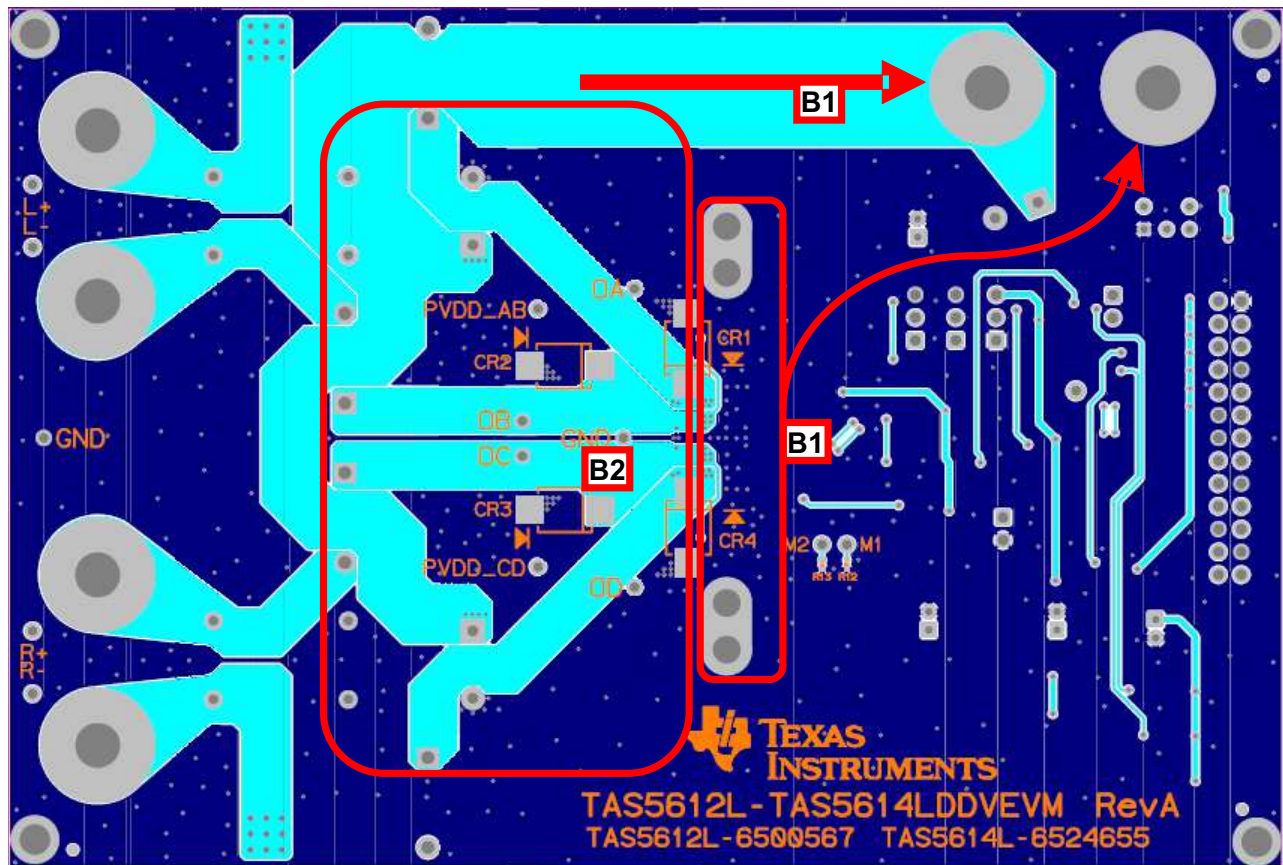

Note B1: A wide PVDD bus and a wide ground path must be used to provide very low impedance to high power and audio currents to the power supply. Top and bottom ground planes must be connected with vias at many points to reinforce the ground connections.

Note B2: Wide output traces can be routed on the bottom layer and connected to output pins with strong via arrays.

Figure 17. Printed Circuit Board - Bottom Layer

PACKAGING INFORMATION

Orderable Device	Status ⁽¹⁾	Package Type	Package Drawing	Pins	Package Qty	Eco Plan ⁽²⁾	Lead/ Ball Finish	MSL Peak Temp ⁽³⁾	Samples (Requires Login)
TAS5612LADDV	ACTIVE	HTSSOP	DDV	44	35	Green (RoHS & no Sb/Br)	CU NIPDAU	Level-3-260C-168 HR	
TAS5612LADDVR	ACTIVE	HTSSOP	DDV	44	2000	Green (RoHS & no Sb/Br)	CU NIPDAU	Level-3-260C-168 HR	

⁽¹⁾ The marketing status values are defined as follows:

ACTIVE: Product device recommended for new designs.

LIFEBUY: TI has announced that the device will be discontinued, and a lifetime-buy period is in effect.

NRND: Not recommended for new designs. Device is in production to support existing customers, but TI does not recommend using this part in a new design.

PREVIEW: Device has been announced but is not in production. Samples may or may not be available.

OBsolete: TI has discontinued the production of the device.

⁽²⁾ Eco Plan - The planned eco-friendly classification: Pb-Free (RoHS), Pb-Free (RoHS Exempt), or Green (RoHS & no Sb/Br) - please check <http://www.ti.com/productcontent> for the latest availability information and additional product content details.

TBD: The Pb-Free/Green conversion plan has not been defined.

Pb-Free (RoHS): TI's terms "Lead-Free" or "Pb-Free" mean semiconductor products that are compatible with the current RoHS requirements for all 6 substances, including the requirement that lead not exceed 0.1% by weight in homogeneous materials. Where designed to be soldered at high temperatures, TI Pb-Free products are suitable for use in specified lead-free processes.

Pb-Free (RoHS Exempt): This component has a RoHS exemption for either 1) lead-based flip-chip solder bumps used between the die and package, or 2) lead-based die adhesive used between the die and leadframe. The component is otherwise considered Pb-Free (RoHS compatible) as defined above.

Green (RoHS & no Sb/Br): TI defines "Green" to mean Pb-Free (RoHS compatible), and free of Bromine (Br) and Antimony (Sb) based flame retardants (Br or Sb do not exceed 0.1% by weight in homogeneous material)

⁽³⁾ MSL, Peak Temp. -- The Moisture Sensitivity Level rating according to the JEDEC industry standard classifications, and peak solder temperature.

Important Information and Disclaimer: The information provided on this page represents TI's knowledge and belief as of the date that it is provided. TI bases its knowledge and belief on information provided by third parties, and makes no representation or warranty as to the accuracy of such information. Efforts are underway to better integrate information from third parties. TI has taken and continues to take reasonable steps to provide representative and accurate information but may not have conducted destructive testing or chemical analysis on incoming materials and chemicals. TI and TI suppliers consider certain information to be proprietary, and thus CAS numbers and other limited information may not be available for release.

In no event shall TI's liability arising out of such information exceed the total purchase price of the TI part(s) at issue in this document sold by TI to Customer on an annual basis.

TAPE AND REEL INFORMATION
REEL DIMENSIONS

TAPE DIMENSIONS

A0	Dimension designed to accommodate the component width
B0	Dimension designed to accommodate the component length
K0	Dimension designed to accommodate the component thickness
W	Overall width of the carrier tape
P1	Pitch between successive cavity centers

TAPE AND REEL INFORMATION

*All dimensions are nominal

Device	Package Type	Package Drawing	Pins	SPQ	Reel Diameter (mm)	Reel Width W1 (mm)	A0 (mm)	B0 (mm)	K0 (mm)	P1 (mm)	W (mm)	Pin1 Quadrant
TAS5612LADDVR	HTSSOP	DDV	44	2000	330.0	24.4	8.6	15.6	1.8	12.0	24.0	Q1

TAPE AND REEL BOX DIMENSIONS



*All dimensions are nominal

Device	Package Type	Package Drawing	Pins	SPQ	Length (mm)	Width (mm)	Height (mm)
TAS5612LADDVR	HTSSOP	DDV	44	2000	346.0	346.0	41.0

MECHANICAL DATA

DDV (R-PDSO-G44) PowerPAD™ PLASTIC SMALL OUTLINE PACKAGE (DIE DOWN)

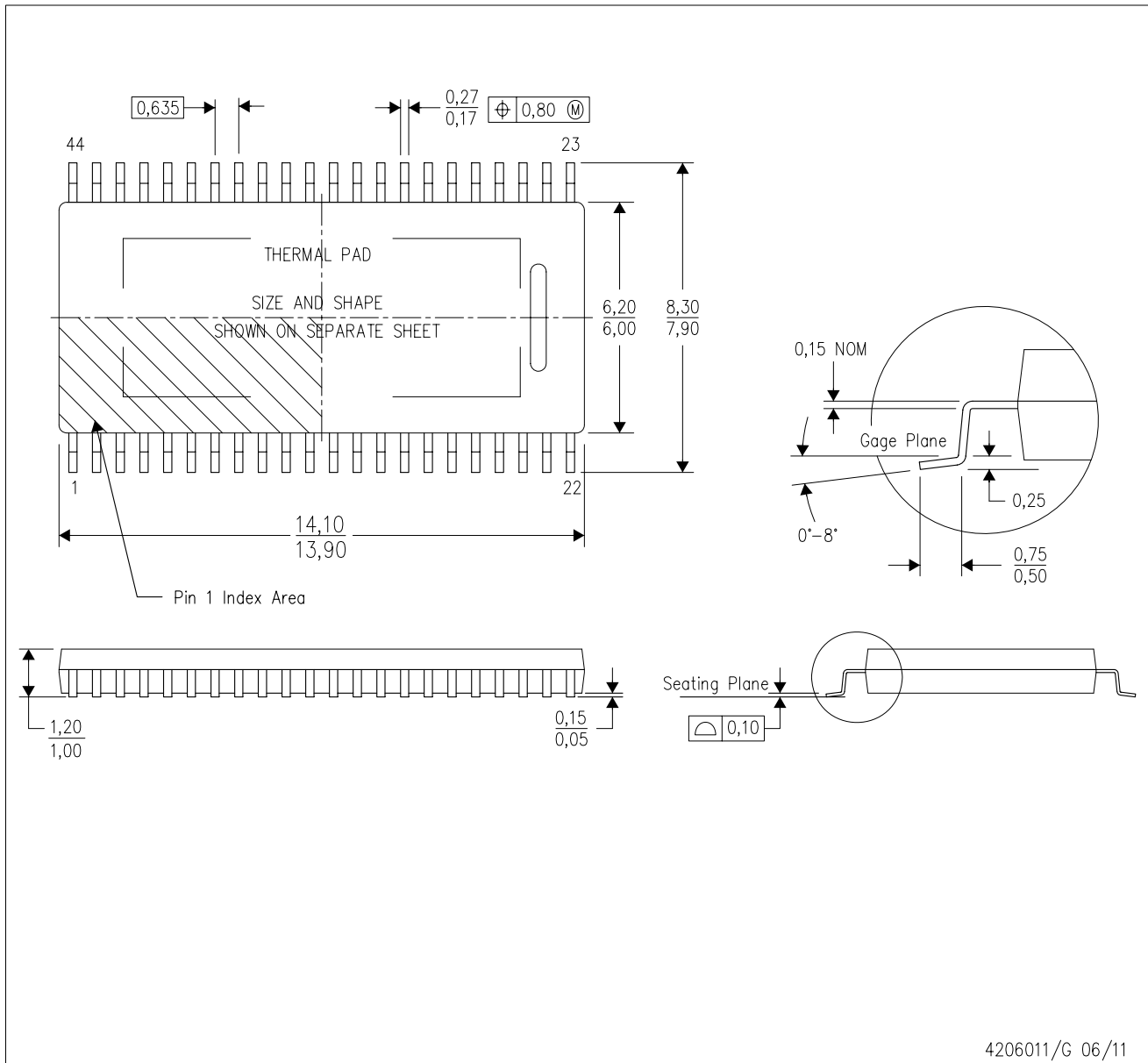

4206011/G 06/11

- NOTES:
- All linear dimensions are in millimeters. Dimensioning and tolerancing per ASME Y14.5M-1994.
 - This drawing is subject to change without notice.
 - Body dimensions do not include mold flash or protrusion not to exceed 0,15.
 - This package is designed to be attached directly to an external heatsink. Refer to Technical Brief, PowerPad Thermally Enhanced Package, Texas Instruments Literature No. SLMA002 for information regarding recommended board layout. This document is available at www.ti.com <<http://www.ti.com>>. See the product data sheet for details regarding the exposed thermal pad dimensions.

PowerPAD is a trademark of Texas Instruments.

THERMAL PAD MECHANICAL DATA

DDV (R-PDSO-G44)

PowerPAD™ SMALL OUTLINE PACKAGE

THERMAL INFORMATION

This PowerPAD™ package incorporates an exposed thermal pad that is designed to be attached directly to an external heatsink. This design optimizes the heat transfer from the integrated circuit (IC).

For additional information on the PowerPAD package and how to take advantage of its heat dissipating abilities, refer to Technical Brief, PowerPAD Thermally Enhanced Package, Texas Instruments Literature No. SLMA002 and Application Brief, PowerPAD Made Easy, Texas Instruments Literature No. SLMA004. Both documents are available at www.ti.com.

The exposed thermal pad dimensions for this package are shown in the following illustration.

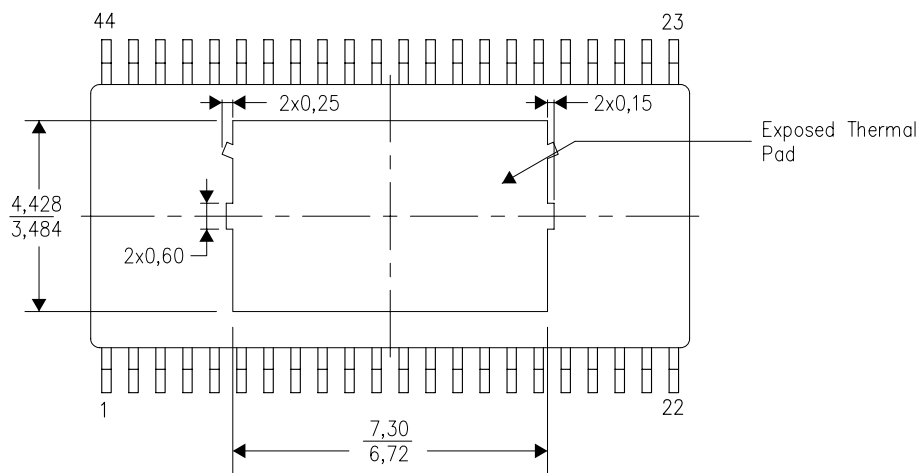

Top View

Exposed Thermal Pad Dimensions

4206975-6/D 07/11

NOTE: All linear dimensions are in millimeters

PowerPAD is a trademark of Texas Instruments

IMPORTANT NOTICE

Texas Instruments Incorporated and its subsidiaries (TI) reserve the right to make corrections, modifications, enhancements, improvements, and other changes to its products and services at any time and to discontinue any product or service without notice. Customers should obtain the latest relevant information before placing orders and should verify that such information is current and complete. All products are sold subject to TI's terms and conditions of sale supplied at the time of order acknowledgment.

TI warrants performance of its hardware products to the specifications applicable at the time of sale in accordance with TI's standard warranty. Testing and other quality control techniques are used to the extent TI deems necessary to support this warranty. Except where mandated by government requirements, testing of all parameters of each product is not necessarily performed.

TI assumes no liability for applications assistance or customer product design. Customers are responsible for their products and applications using TI components. To minimize the risks associated with customer products and applications, customers should provide adequate design and operating safeguards.

TI does not warrant or represent that any license, either express or implied, is granted under any TI patent right, copyright, mask work right, or other TI intellectual property right relating to any combination, machine, or process in which TI products or services are used. Information published by TI regarding third-party products or services does not constitute a license from TI to use such products or services or a warranty or endorsement thereof. Use of such information may require a license from a third party under the patents or other intellectual property of the third party, or a license from TI under the patents or other intellectual property of TI.

Reproduction of TI information in TI data books or data sheets is permissible only if reproduction is without alteration and is accompanied by all associated warranties, conditions, limitations, and notices. Reproduction of this information with alteration is an unfair and deceptive business practice. TI is not responsible or liable for such altered documentation. Information of third parties may be subject to additional restrictions.

Resale of TI products or services with statements different from or beyond the parameters stated by TI for that product or service voids all express and any implied warranties for the associated TI product or service and is an unfair and deceptive business practice. TI is not responsible or liable for any such statements.

TI products are not authorized for use in safety-critical applications (such as life support) where a failure of the TI product would reasonably be expected to cause severe personal injury or death, unless officers of the parties have executed an agreement specifically governing such use. Buyers represent that they have all necessary expertise in the safety and regulatory ramifications of their applications, and acknowledge and agree that they are solely responsible for all legal, regulatory and safety-related requirements concerning their products and any use of TI products in such safety-critical applications, notwithstanding any applications-related information or support that may be provided by TI. Further, Buyers must fully indemnify TI and its representatives against any damages arising out of the use of TI products in such safety-critical applications.

TI products are neither designed nor intended for use in military/aerospace applications or environments unless the TI products are specifically designated by TI as military-grade or "enhanced plastic." Only products designated by TI as military-grade meet military specifications. Buyers acknowledge and agree that any such use of TI products which TI has not designated as military-grade is solely at the Buyer's risk, and that they are solely responsible for compliance with all legal and regulatory requirements in connection with such use.

TI products are neither designed nor intended for use in automotive applications or environments unless the specific TI products are designated by TI as compliant with ISO/TS 16949 requirements. Buyers acknowledge and agree that, if they use any non-designated products in automotive applications, TI will not be responsible for any failure to meet such requirements.

Following are URLs where you can obtain information on other Texas Instruments products and application solutions:

Products

Audio	www.ti.com/audio
Amplifiers	amplifier.ti.com
Data Converters	dataconverter.ti.com
DLP® Products	www.dlp.com
DSP	dsp.ti.com
Clocks and Timers	www.ti.com/clocks
Interface	interface.ti.com
Logic	logic.ti.com
Power Mgmt	power.ti.com
Microcontrollers	microcontroller.ti.com
RFID	www.ti-rfid.com
OMAP Mobile Processors	www.ti.com/omap
Wireless Connectivity	www.ti.com/wirelessconnectivity

Applications

Automotive and Transportation	www.ti.com/automotive
Communications and Telecom	www.ti.com/communications
Computers and Peripherals	www.ti.com/computers
Consumer Electronics	www.ti.com/consumer-apps
Energy and Lighting	www.ti.com/energy
Industrial	www.ti.com/industrial
Medical	www.ti.com/medical
Security	www.ti.com/security
Space, Avionics and Defense	www.ti.com/space-avionics-defense
Video and Imaging	www.ti.com/video

TI E2E Community Home Page

e2e.ti.com

Mailing Address: Texas Instruments, Post Office Box 655303, Dallas, Texas 75265
Copyright © 2012, Texas Instruments Incorporated